

CI/SfB			
	(22.3)	x	K2

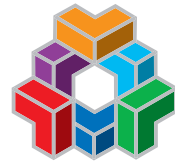

tenon
PARTITIONS



The beauty of natural wood



Areas of use 4 4 4 4 4

Fire performance

Solid modules - up to 60 minute fire rating.
 Glazed modules - up to 57 minute fire rating in both centre single and double glazed applications.
 Door modules - up to 57 minute fire rating.

Acoustic performance

Solid modules - standard construction - up to 52dB.
 Glazed modules - standard construction - up to 40dB.
 Door modules - standard solid door core - up to 30dB.

Construction Options

Solid modules - standard construction is with 12.5mm plasterboard panels with a wide choice of finishes together with numerous joint and trim options.
 Glazed modules - includes offset single and double glazing, together with both single and double silicone glazing and the option of Venetian blinds.
 Door modules - standard frames are supplied to suit 1981 x 838 x 44mm doors. Frames will also accept most types of doors.

Max Construction Heights

Solid modules - standard construction - up to 3000mm. Sections may be supplied to achieve heights of 3300mm.
 Glazed modules - maximum recommended height using standard sections - 3000mm.



Versatility

Tenon Scion has been designed to provide the specifier with a readily available system that combines the natural look and finish of timber with the ease of installation and relocation of a modern partition system.

Using all timber components for door and glazing frames, a high quality effect is created. The system can be tailored for use in reception areas, conference facilities, boardroom's, executive suites or general office areas.

Solid panel elements can be either flush faced for monolithic effect - or where both relocatability and attractive feature joints are required, the panels are pre-venyled with the wallcovering of your choice. A choice of "pencil-line" or 'V' joints is then available.

A choice of timbers can be made to suit the available budget and interior design scheme. As a standard we offer American Cherry, Ash, American White Oak and Beech.





Vision panels of almost any shape or size can be incorporated to conform with building regulations and fire officer requirements.

Many timbers are available subject to suitability of raw material. Where possible it is our policy to only source from managed forests in North America, Europe and Africa.

Adaptability

Double-glazing accommodates 15mm and 25mm Venetian blinds and vertical blinds within the partition void, with operation via control knobs located within special posts. Manifestation films may be applied to glazed modules to create eye-catching designs while also providing compliance with Building Regulations and maintaining privacy levels.

Scion has been thoroughly tested and assessed over a number of years and offers 30-minute fire resistance to BS 476 part 22. Solid modules with feature joints, door modules including all configurations of door leaves and glazed modules in double and single offset glazed formats including insulated glazing all provide a minimum half hour performance. Standard components can also be used to achieve 57 minutes glazing and door integrity.

For more information or advice on this system's performance please contact the Tenon Technical Department.



Flexibility

75mm solid panel elements including feature joints, provide sound reduction ratings of between 37 to 43dB_(RW). Standard module size is 1200mm wide and up to 3000mm high with a system width of either 75mm or 100mm. Standard detailing includes 90°, 135°, 'Y' and three way solid posts suitable for use in all types of modules. Special non-standard posts are available as part of the Scion design package.

Timbers are finished with a water-based lacquer but may be stained to meet any colour scheme requirements.

All fixings are concealed by either shadow line or plastic insert trims that are colour coded to a choice of RAL colours to match door furniture or corporate colours.

To compliment Tenon Scion, the Nexus range of ironmongery offers a wide choice of door furniture in a variety of finishes.



Tenon Scion is a fully demountable and relocatable timber framed partition system that has been designed to be a fully fire and sound rated solution for specifiers and end users. Utilising solid timber components, Scion has been developed and tested over a number of years, providing true flexibility and adaptability within design environments.

Timbers

Types of timber readily available include ash, oak, cherry, beech and maple, however many other species may be specified subject to their availability and suitability of use in a heated office environment. Wherever possible raw materials are sourced from managed, renewable sources.

Size

Standard module size is up to 3000mm high x 1200mm wide x 75mm thick, with a standard head channel thickness of 113mm. Other heights, module sizes and partition thicknesses can be accommodated within the system to meet most specifications. Please contact the Tenon Technical Department for guidance.

Appearance

All timber sections are supplied with a clear base coat and water based lacquer finish as standard. In situations where the chosen timber is unsuitable for manufacture, a similarly grained species can be stained to match customer requirements.

NB. If ordering untreated profiles, site conditions must be taken into consideration to prevent the swelling, twisting or warping of sections.

A plastic snap in omega insert is used to conceal fixings within external trims and is available in a light and dark grey finish as standard but may be coated in a wide range of colours to suit any interior design scheme.

Components

The main components of the system are a solid timber head channel section (TS510), a universal timber upright post or transom section fitted using a patented bracketing system, and on solid elevations only a galvanised steel stud (TF201). Details of the bracket can be found on page 13 while component descriptions appear on page 15 - 16.

Glazing

All glazing is flush and available in offset single and double glazed formats as shown below: -

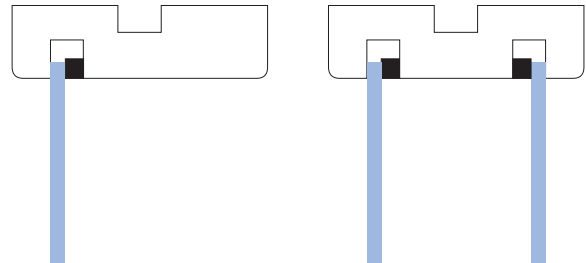

Offset Single Glazing

Double Glazing

Standard Scion glazing sections will accept glass of between 6mm and 12mm in thickness in either single or double glazing, in both standard and silicone glazed formats. Other sizes of glass may be accommodated within specially adapted profiles to improve both fire and acoustic performance.

When specifying or installing glazing, special care must be paid to the Building Regulations Approved Document Part N 1992, BS6262 : 1982 Code of Practice for building and BS6206 Impact performance requirements.

Integral Blinds

When glazing with standard 6mm safety glass, Scion has an internal void of 61mm and therefore can accommodate both Venetian and vertical blinds within double glazed modules. The control mechanism for the blinds is housed within a special post (TS521/581)

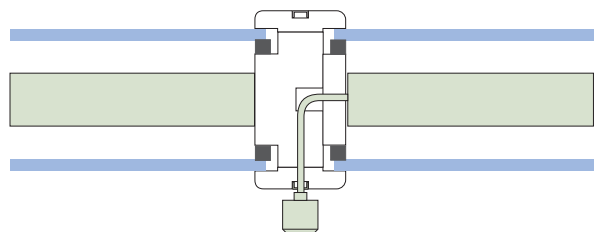

Door Modules

All standard frames are universal (i.e. they suit left or right hand hanging) allowing the decision of handing to be made on site, providing flexibility for 'last minute' layout changes. Frames are supplied as a module pack, and include the door frame and a pre-cut transom that facilitates the correct spacing for the adjacent timber studs.

All frames have a rebate for the fitting of intumescent strip/cold smoke seal to conceal fixings and meet fire rating specifications. Standard door frame packs are available for 1981 x 838mm x 44mm and 2040mm x 826mm x 44mm leaves. Other sizes including full height, hospital and double door sets are also readily available.

Matching doors and over panels are also easily accommodated within full height frames. Cover trims cloak the door frame uprights and are taken either directly to the floor level or to the top of a skirting block. Examples of the options available are shown on page 13.

Door Furniture

Standard furniture includes the following finishes,

- SAA (which can be colour coated to any RAL colour)
- Polished brass
- Polished stainless steel
- Solid nylon or steel cored nylon in a range of colours.

The range includes lever sets, mortice or cylinder sets, escutcheons, pull handles, push and kickplates, and complementary accessories.

Furniture can be ordered in shrink wrapped co-ordinated sets containing lever sets, lock, hinges, lockplate, escutcheons and fixing screws, or as separate items. The range may be specified for use on both partitions and general use doorsets. Matching closers complete the set.

Fire

Tenon Scion has been thoroughly tested and assessed over a number of years to meet the requirements of Fire and Building Control officers. Where glazed areas are installed in fire rated partitions, it is the responsibility of the installer to ensure that the area and location of the glass is acceptable to the relevant local Fire Authority. All fire tests were carried out in accordance with BS 476 PT 22, 1987. Test results and assessments enable us to offer 30 minutes fire rating on elevations which include:

SOLID PANELS Continuous runs of 12.5mm plasterboard which may feature various joint details.

DOORS Single Height, Leaf and over panel, Full Height.

GLAZING Single and double glazed modules up to 2.7m high x 1.2m wide using georgian wired safety

glass as the corridor pane and 6.1m clear laminated glass for the sacrificial pane. Pyran, pyrobel and other types of clear fire rated glass may be accommodated within the system please check with Tenon Partition Technical Department. Glazing is also available with 30 minutes insulation. Full details of the acoustic performance of the system are included in a table on page 15.

Acoustic Performance

Tenon Scion has been thoroughly tested in accordance with BS 2750 part 3, 1980: ISO 140/11 - 1978 and will achieve the following:

SOLID PANELS Up to 52dB, using suitable board material.

GLAZING Up to 40dB, in double glazed applications.

DOORS Up to 30dB when using a suitable threshold seal.

Full details of the acoustic performance of the system are included in a table on page 15.

It should be noted that all the above results were obtained under laboratory test conditions. The expected level of performance should take into account the type of ceiling, ducting, flooring etc present. The leakage of sound through poorly insulated parts of the partition will have a significant effect on the level of sound attenuation possible.

Solid Modules

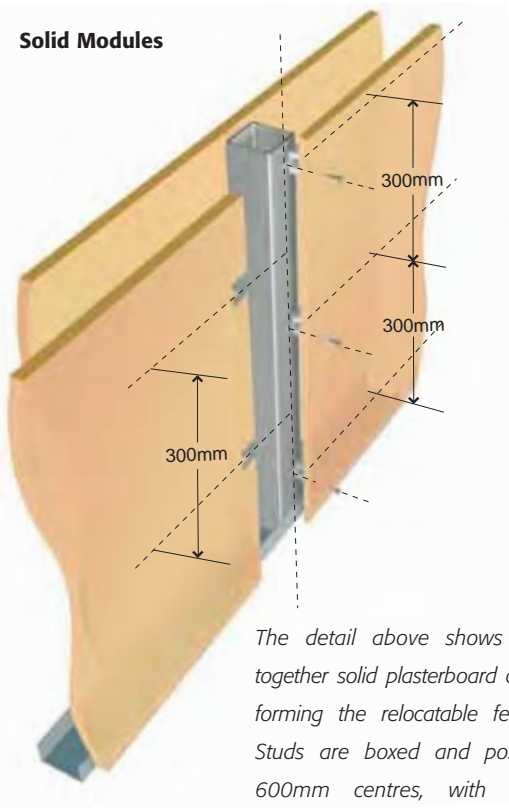

The detail above shows the "clip" together solid plasterboard construction forming the relocatable feature joint. Studs are boxed and positioned at 600mm centres, with the joints "staggered" on each side of the partition.

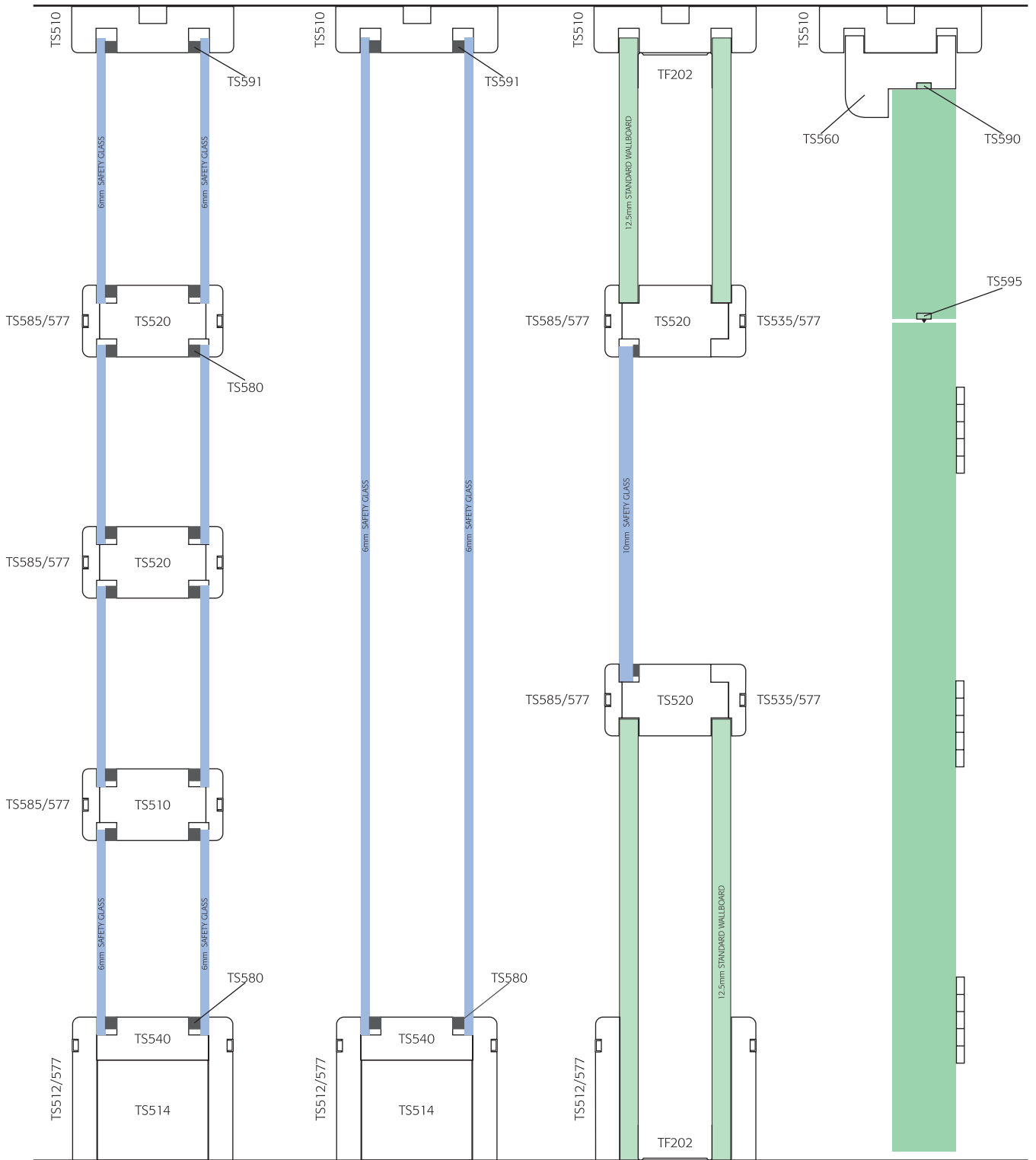

Elevation Details

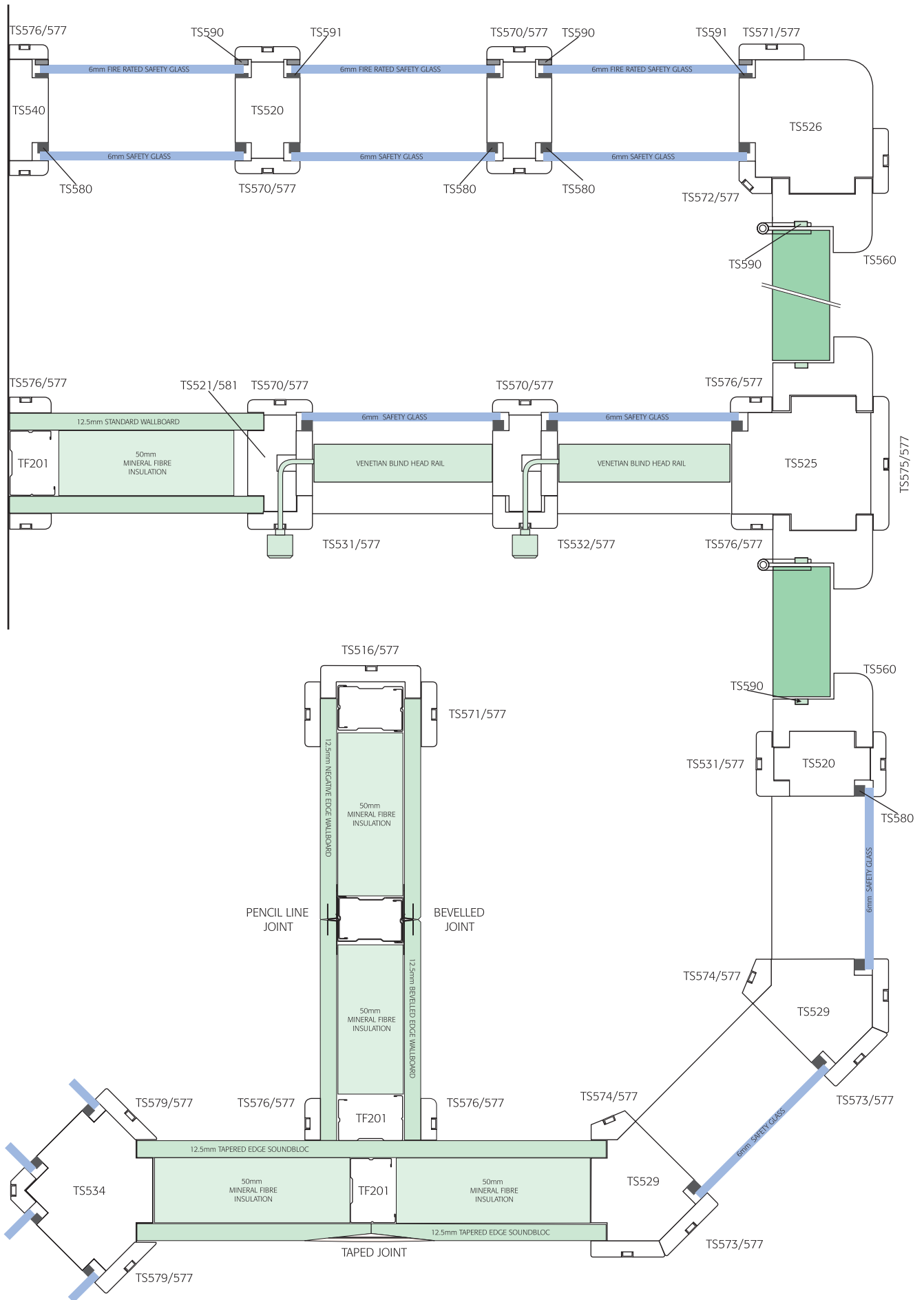

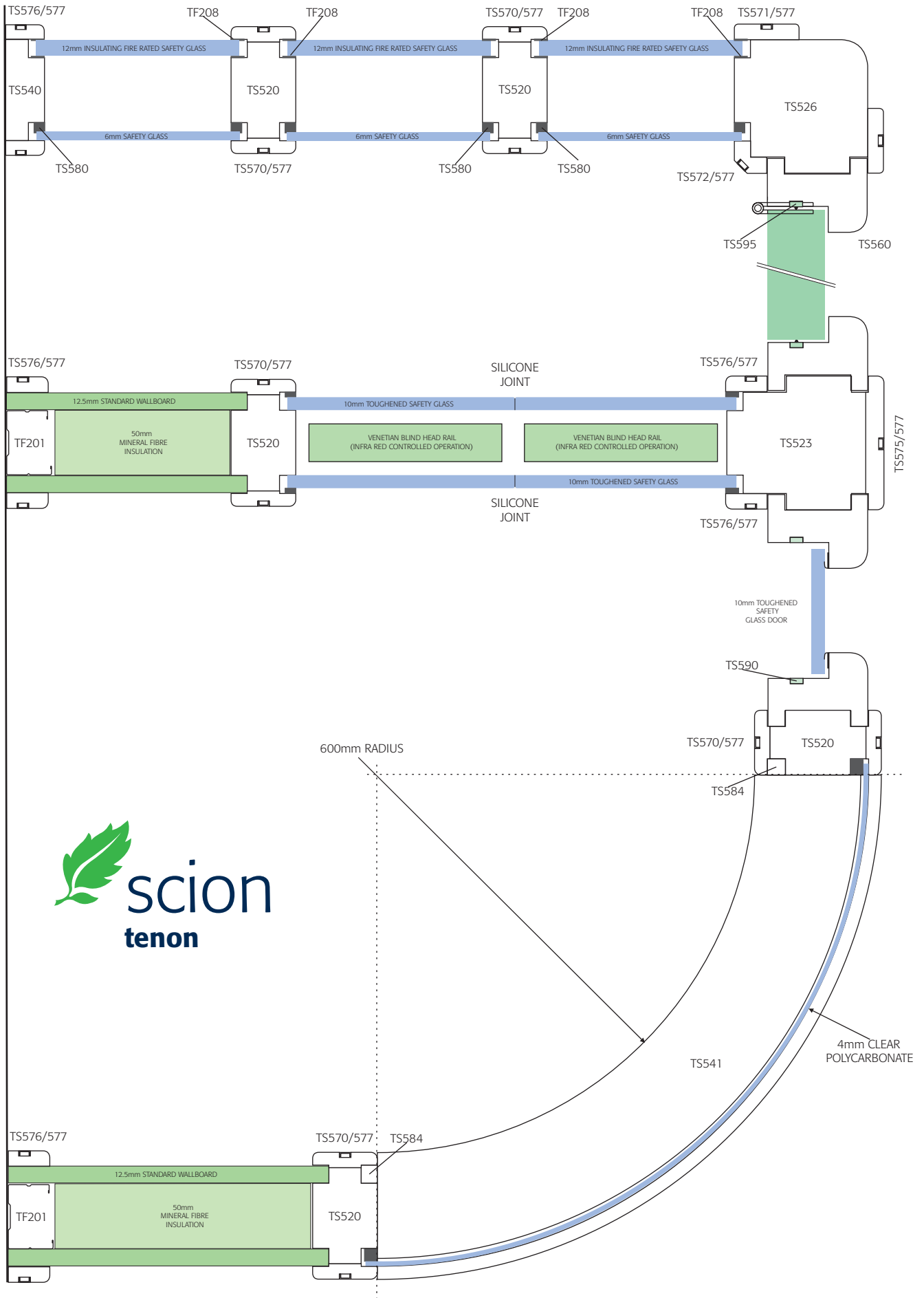

Plan Details

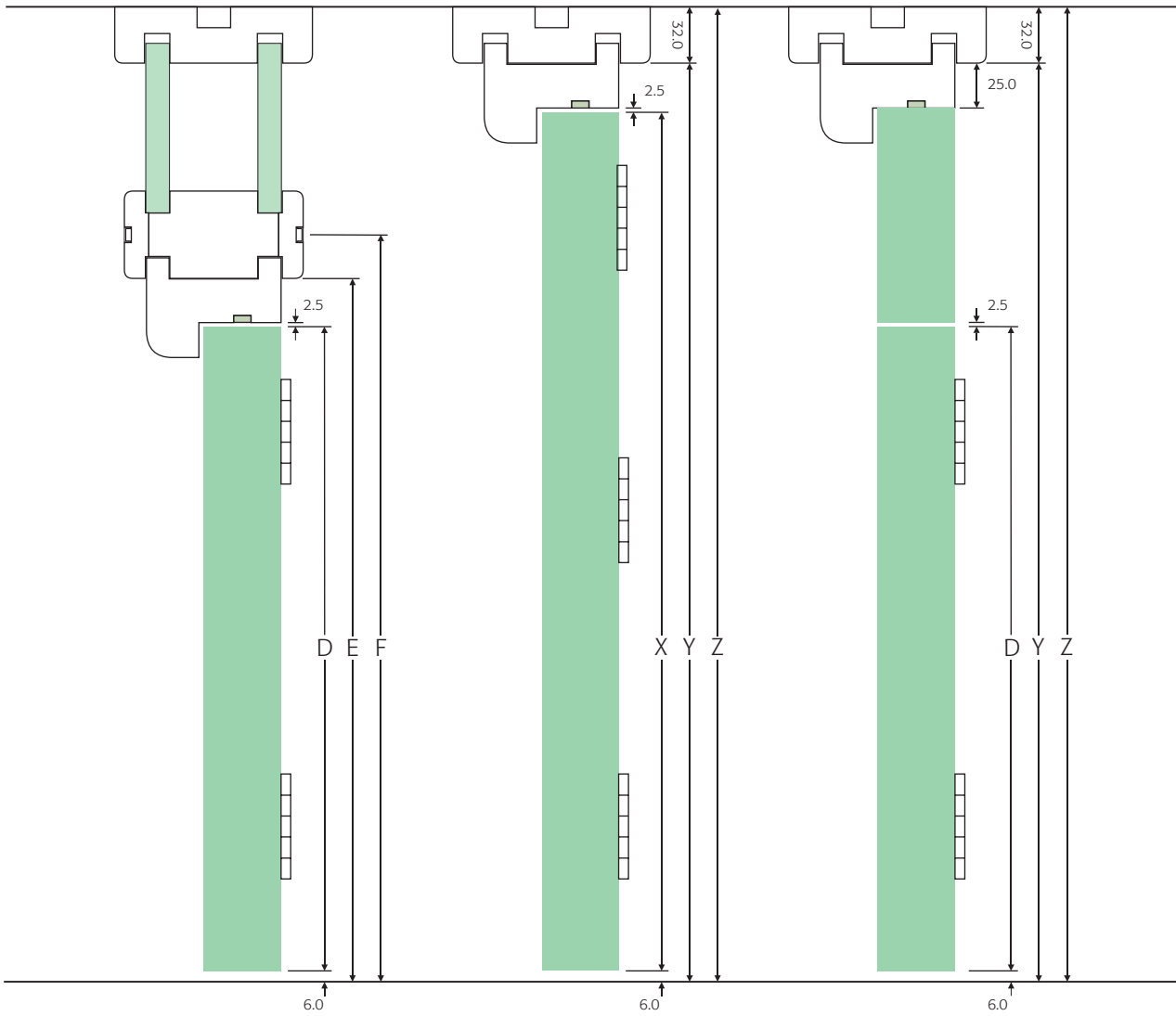
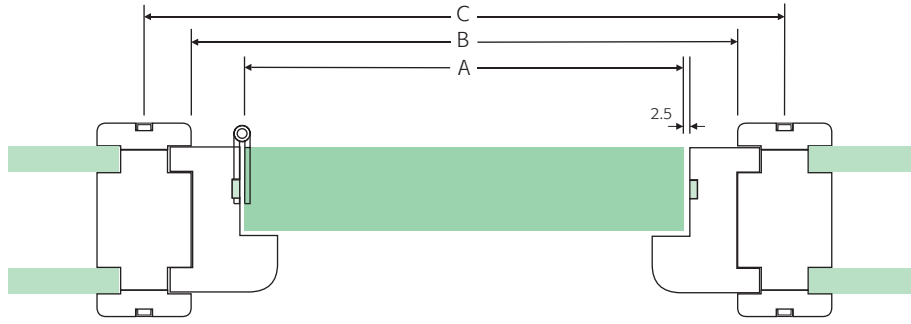

Plan Details





	WIDTH			
	SINGLE		DOUBLE	
	METRIC	IMPERIAL	METRIC	IMPERIAL
DIM A	826mm	838mm	1652mm	1676mm
DIM B	Dim A + 56mm	Dim A + 56mm	Dim A + 59mm	Dim A + 59mm
DIM C	Dim A + 106mm	Dim A + 106mm	Dim A + 108mm	Dim A + 108mm

	HEIGHT		
	SINGLE		FULL HEIGHT
	METRIC	IMPERIAL	METRIC - IMPERIAL
DIM D	2040mm	1981mm	DIM X Dim Z - 66mm
DIM E	Dim D + 34mm	Dim D + 34mm	DIM Y Dim Z - 32mm
DIM F	Dim D + 59mm	Dim D + 59mm	DIM Z Floor to Ceiling Height

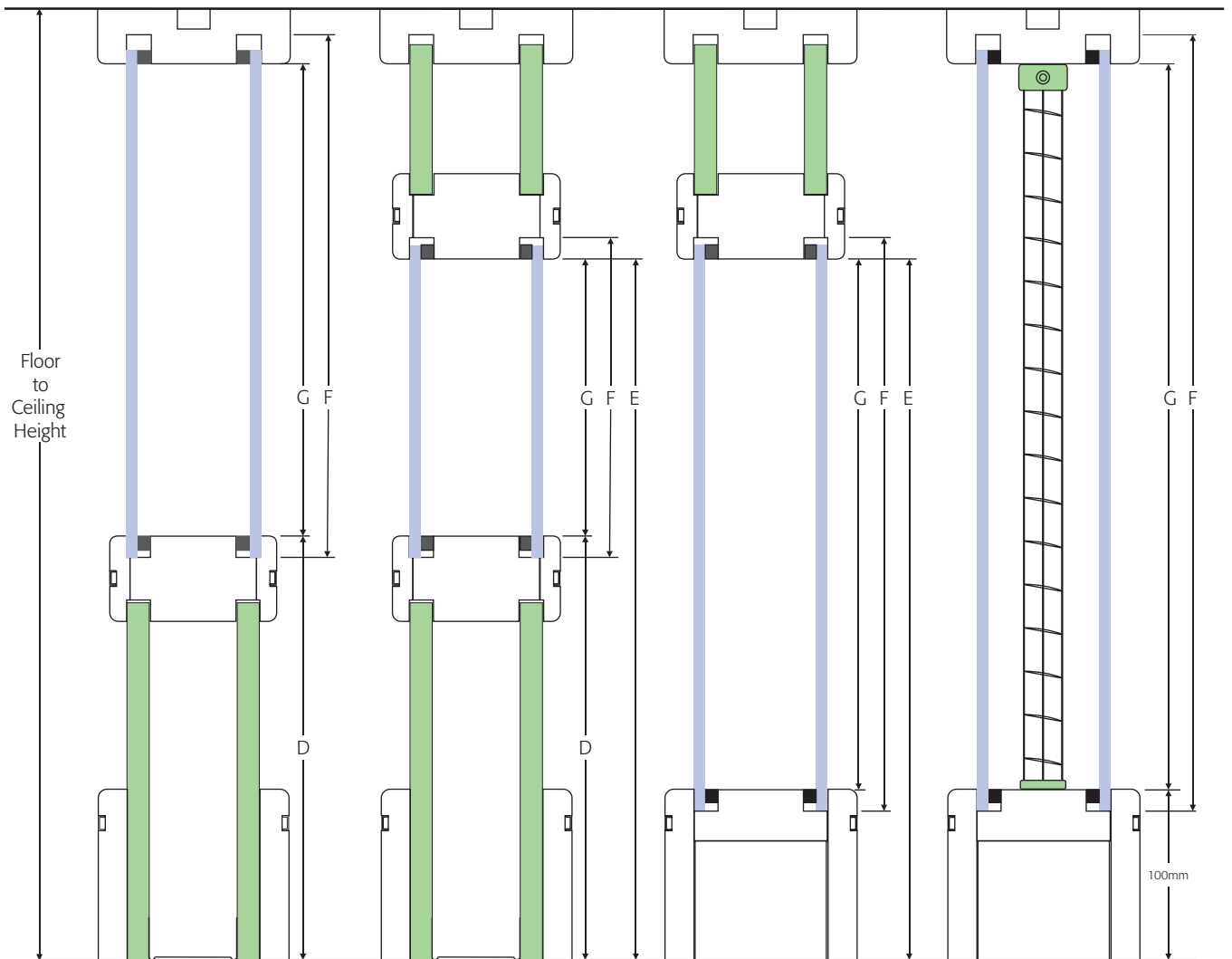
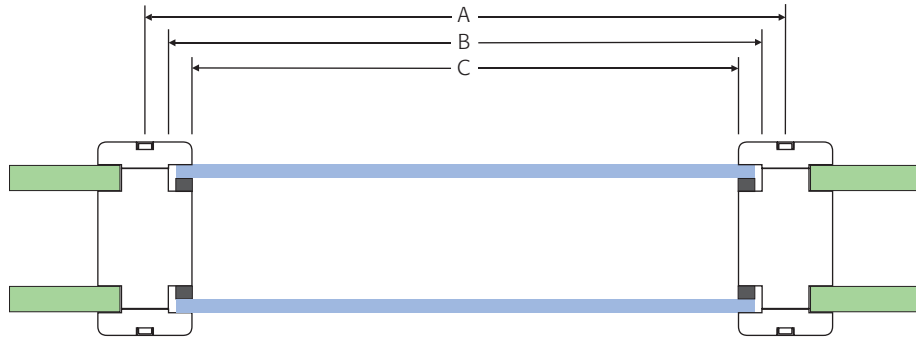
Door Frame Setting Out Details



	WIDTH			HEIGHT						
	STANDARD MODULE			HALF GLAZED* (1200 x 1200)	HALF GLAZED** (1500 x 1200)	MID GLAZED (800 x 1200)	MID GLAZED (1000 x 1200)	GLAZED TO DOOR HEAD*** (1900 x 300 nom)	FULL HEIGHT WITH 75MM SKIRTING	FULL HEIGHT WITH 100mm SKIRTING
DIM A	1200mm	Dado Transom Height	DIM D	1225mm	1225mm	1240mm	1040mm	N/A	N/A	N/A
DIM B	Dim A - 25mm	Door Head Transom Height	DIM E	N/A	N/A	Door Height + 34mm	Door Height + 34mm	Door Height + 34mm	N/A	N/A
DIM C	Dim A - 50mm	Glass Aperture Dimension	DIM F	1173mm	1473mm	Dim E - 1240mm	Dim E - 1040mm	Dim E - 125mm	Floor to Ceiling Height - 79mm	Floor to Ceiling Height - 107mm
		Blind Aperture Dimension	DIM G	1143mm	1443mm	Dim E - 1265mm	Dim E - 1065mm	Dim E - 100mm	Floor to Ceiling Height - 107mm	Floor to Ceiling Height - 132mm

* Assumes a floor to ceiling height of 2400mm
 ** Assumes a floor to ceiling height of 2700mm
 *** Assumes the use of 100mm skirting

Glazing Setting Out Details

Scion patented bracket

Tenon scion is built with the use of a patented bracketing system unique to Tenon. Developed to allow for the efficient and speedy fitting of both uprights and transoms the brackets eliminate the need for the angled fixing of components and the filling of pre-drilled holes.



TS500

used to fix upright posts to the underside of the solid timber head channel.

TS500B

used to fix upright posts to the timber base section and to fit transoms.

Taking an off cut of head channel set the TS500 bracket to the correct depth to fix into the head channel recess. Fix into place using wafer head self drill screws.



Ensuring that the post is plumb, place the TS500B bracket onto the underside of the upright post and the face of the base section. Fix into position using a wafer head screw.

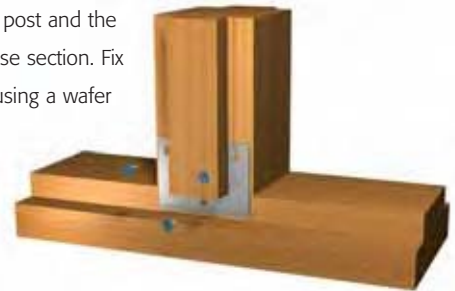

Offer the post up to the head channel and locate within the rebates on either side of the section. Fix into position using wafer head self drill screws.



To fit a transom, fix a TS500B bracket at the correct depth at the end on both sides of the section. Ensuring that the transom is level, fix into position using wafer head self drill screws.

Alternative Skirting Details



TS512 Mitred Skirting

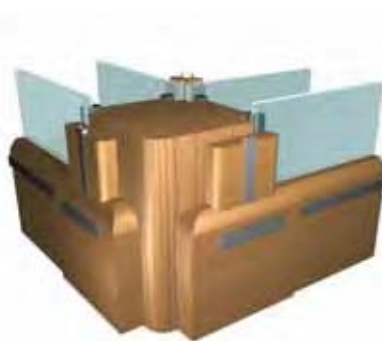

TS512 with Skirting Block



TS512 with Chamfered End



TF 201 50mm GALVANISED STEEL STUD
used for all vertical framework on all solid full height elevations.



TF 202 52mm GALVANISED STEEL TRACK
used for the base track of full height solid and part/half glazed modules only.



TS 500 UNIVERSAL STEEL 'U' BRACKET
for fixing all timber uprights to the underside of the head channel TS510/511.



TS 500B UNIVERSAL STEEL 'U' BRACKET
for fixing upright posts to base sections when installing full height glazing and for the fitting of transoms.

TS 501 PLASTERBOARD EDGE FIXING CLIPS
for fixing negative edge and bevelled edge boards to TF 201 studs and TS 522/S studs.

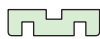

TS 510 113mm TIMBER HEAD CHANNEL
for double glazed and solid panel into head details. Can also be used as a wall abutment on solid full height elevations.

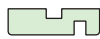

TS 511 113mm TIMBER HEAD CHANNEL
for single glazed into head details only.



TS 512 100mm TIMBER SKIRTING PROFILE



TS 513 75mm TIMBER SKIRTING PROFILE



TS 514 78mm x 70mm TIMBER BASE
for full height glazing, use with TS 530 or TS 540 glazing chairs and 100mm TS 512 skirting profile.



TS 515 78mm x 45mm SOFTWOOD BASE
for full height glazing (with TS 513 75mm skirting profile).



TS 520 50mm TIMBER UNIVERSAL UPRIGHT POST
used for all vertical glazing uprights, door frame and horizontal transoms eg. TS 520/12 is a standard transom pre-cut to provide a 1200mm module width).

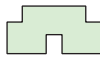

TS 521 50mm TIMBER UPRIGHT POST
when used with timber glazing chair (ref TS 581) provides the upright for use with integral blinds and double glazing and electrical switches.



TS 522 50mm TIMBER UPRIGHT POST
for use only on the vertical glazing section of half or part glazed modules with 2 no TS 522.



TS 522/S 50mm TIMBER STUD
used as intermediate vertical stud only above and below transoms on part glazed modules.



TS 523 77mm 3-WAY TIMBER UPRIGHT POST
to be used in conjunction with 1 no TS 524 and 2 no TS 575 to provide a 3-way junction that accepts a combination of double glazing, doors or solid.



TS 525 77mm 3-WAY TIMBER UPRIGHT POST
as TS 523 but for single glazed only.



TS 526 92mm TIMBER 90° RADIUS CORNER POST MAIN SECTION
used with cover trims TS 571 (2 no) and TS 572 internal angle. Allows any combination of double glazing, solid or door elements to meet at 90°.



TS 527 92mm TIMBER 90° RADIUS CORNER POST MAIN SECTION
as TS 526 but for single glazed only.



TS 528 80mm TIMBER 135° UPRIGHT POST MAIN SECTION
when used with cover trims TS 573 (2 no) and TS 574 internal angle allows any combination of double glazed, solid or double element to meet at 135°.



TS 529 80mm TIMBER 135° UPRIGHT POST MAIN SECTION
As for TS 528 but for single glazing only.



TS 530 78mm TIMBER SINGLE OFFSET GLAZING CHAIR
can also be used as a breakdown wall abutment when used with 2 no TS 576.



TS 531 50mm TIMBER SINGLE OFFSET LEG COVER TRIM
used where single glazing adjoins doors or solid panels.



TS 532 50mm TIMBER DOUBLE OFFSET LEG COVER TRIM
used on the non glazed side of uprights and transoms in single glazing only.



TS 534 80mm Y POST
main section when used with 2 no TS 579 and 1 no TS 572, for double glazed and solid junctions only.



TS 535 50mm TIMBER REDUCED THICKNESS HORIZONTAL TRANSOM
for use in banded single glazing and door modules.



TS 536 50mm TIMBER REDUCED THICKNESS HORIZONTAL TRANSOM
for use in banded single glazing and door modules.



TS 540 78mm TIMBER BASE DOUBLE GLAZING CHAIR
can be used as a breakdown wall abutment when used with 2 no TS 576 (1 each side).



TS 561 77mm TIMBER SINGLE UNIVERSAL (i.e. Non Handed) DOOR FRAME PACK
1/2 hour fire rated to suit 1981 x 838 x 44 leaf includes TS 560 - door frame section with provision for intumescent strip TS 595. TS 520/830 timber transom section pre-cut to allow easy setting out of adjacent uprights.



TS 570 50mm TIMBER STANDARD COVER TRIM
for all vertical and horizontal glazing and door frame trimming. Includes a recess to allow 'shadow line' of exposed fixings or can be used with TS 577 9mm plastic infill to conceal fixings.



TS 571 55mm TIMBER EXTERNAL COVER TRIM
for 90° (TS 526 or TS 527) upright posts (2 per upright post).



TS 572 90° INTERNAL COVER TRIM
for 90° post (TS 526 or TS 527).



TS 573 55mm EXTERNAL 135° COVER TRIM
for 135° posts (TS 528 or TS 529).



TS 574 INTERNAL 135° TIMBER COVER TRIM
for 135° posts (TS 528 or TS 529).



TS 575 3 WAY POST COVER TRIM
for use with 3 way posts TS 523 or TS 525.



TS 576 TIMBER HALF COVER TRIM
for use with breakdown post at walls i.e. 2 no required with TS 540 - for double glazing and solid modules and TS 530 - for single offset glazing only.



TS 577 9mm x 4mm LIGHT GREY PLASTIC OMEGA INFILL
for use with cover trims, to conceal fixings if required.



TS 578 9mm x 4mm PLASTIC OMEGA INFILL
colour coated to RAL colours.



TS 579 55mm 'Y' POST COVER TRIM
external cover trim for 'Y' post TS 534.



TS 580 FOAM GLAZED BEAD
for single or double glazing, on non-fire rated modules. Use TS 580 for all applications except where glazing meets head channel at ceiling, here TS 591 must be used.



TS 581 50mm TIMBER 'PLANT' ON BEAD
to create glazing 'chair' on integral blind posts (TS 521).



TS 582 25mm TIMBER 'PLANT' ON BEAD
for use with half glazed posts (TS 521) with standard cover trims TS 570. Only required on glazed section of uprights on part or half glazed modules.



TS 585 50mm TIMBER REDUCED THICKNESS HORIZONTAL TRANSOM COVER TRIM
for use in banded glazing and door modules.



TS 588 BLANK SKIRTING BLOCK
suitable for finishing door architrave/skirting detail. Conceal fixing using timber plugs.



TS 589 SKIRTING BLOCK c/w OMEGA TRIM
suitable for finishing door architrave/skirting detail. Concealed fixing using omega trim.



TS 590 10mm x 4mm 1/2 HOUR GLAZING INTUMESCENT BEAD
only required on the outside face of the fire rated glass, use with TS 591 glazing bead on inside.



TS 591 11.5 x 6mm GLAZING FOAM
for use with fire rated modules.



TS 595 10mm x 4mm 1/2 HOUR FIRE RATED COMBINED INTUMESCENT STRIP & COLD SMOKE SEAL
for use with TS 560, 1/2 fire rated frames.

N.B. All trim sections are available without rebates to allow sections to be pinned.

 Performance Summary			
	SYSTEM	75mm Scion	100mm Scion
FIRE	CONSTRUCTION	One layer of 12.5mm plasterboard fitted either side of Tenon 50mm stud with 50mm mineral fibre slab in cavity	Two layers of 12.5mm plasterboard fitted either side of Tenon 50mm stud with 50mm mineral fibre slab in cavity
30 Minutes Integrity 30 Minutes Insulation	SOLID TS571 Cover Trim	4	4
	SOLID Bevelled Joint	4	4
	SOLID Pencil-Line joint	4	4
	SOLID Taped Joint	4	4
60 Minutes Integrity 60 Minutes Insulation	SOLID TS571 Cover Trim		4
	SOLID Taped Joint		4
30 Minutes Integrity*	GLAZED Single Glazing	4	4
	GLAZED Double Glazing	4	4
30 Minutes Integrity*/Insulation**	GLAZED Double Glazing	4	4
57 Minutes Integrity	GLAZED Double Glazing	4	4
30 Minutes Integrity	DOOR Single Door	4	4
	DOOR Double Door	4	4
	DOOR Hospital Door	4	4
	DOOR Full Height Door	4	4
	DOOR Full Height Door & OP	4	4
57 Minutes Integrity	DOOR Single Door	4	4
	DOOR Full Height Door	4	4
	DOOR Full Height Door & OP	4	4









* Pyroshield safety glass, Pyran, Pyroacet and Pyroguard only. ** Pyrobel glass only.

ACOUSTIC / STRUCTURAL	Stud Size	Single Boxed	Plasterboard / Glass Type	Plasterboard / Glass Thickness	Single / Double	Insulation Type	dB Rating	Maximum Construction Height
75mm Solid	50mm	Single	Standard	12.5mm	Single Skin	None	34dB(RW)	3000mm
	50mm	Single	Feature Joint	12.5mm	Single Skin	None	37dB(RW)	3000mm
	50mm	Single	Standard	12.5mm	Single Skin	50mm 45kg/m ³	40dB(RW)	3600mm
	50mm	Single	Feature Joint	12.5mm	Single Skin	50mm 45kg/m ³	43dB(RW)	3600mm
100mm Solid	50mm	Single	Standard	12.5mm	Double Skin	None	42dB(RW)	3600mm
	50mm	Single	SoundBloc	12.5mm	Double Skin	None	46dB(RW)	3600mm
	50mm	Boxed	Standard	12.5mm	Double Skin	50mm 45kg/m ³	49dB(RW)	4200mm
	50mm	Boxed	SoundBloc	12.5mm	Double Skin	50mm 45kg/m ³	52dB(RW)	4200mm
75mm Glazed	50mm	Boxed	Laminated	6.4mm	Single Glazed	N/A	33dB(RW)	3300mm
	50mm	Boxed	Acoustic Lam	6.8mm	Single Glazed	N/A	35dB(RW)	3300mm
	50mm	Boxed	Laminated	6.4mm	Double Glazed	N/A	35dB(RW)	3300mm
	50mm	Boxed	Acoustic Lam	6.8mm	Double Glazed	N/A	40dB(RW)	3300mm
100mm Glazed	50mm	Boxed	Laminated	6.4mm	Double Glazed	N/A	35dB(RW)	3300mm
	50mm	Boxed	Acoustic Lam	6.8mm	Double Glazed	N/A	40dB(RW)	3300mm
Door Modules		Boxed					30dB(RW)	

* Please consult the Tenon Partition Technical Department for advice on glazed partitions above 3300mm.



Scion is only one of the systems that forms the Tenon range. Other products in the range include:

- | | |
|--|--|
|  fire & sound |  washrooms |
|  flexplus |  operable walls |
|  ovation |  silicon glazed |
|  wall store |  accessories |

ESEPROJECTS
Design, Supply & Install Services

Wensum Works,
150 Northumberland Street
Norwich, Norfolk, NR2 4EE

Phone: +44 (0)1603 629956
Fax: +44 (0)1603 630113

Email: sales@eseprojects.co.uk
Web: www.eseprojects.co.uk