

Thank you for purchasing a Sealey product. Manufactured to a high standard this product will, if used according to these instructions and properly maintained, give you years of trouble free performance.

**IMPORTANT: PLEASE READ THESE INSTRUCTIONS CAREFULLY. NOTE THE SAFE OPERATIONAL REQUIREMENTS, WARNINGS & CAUTIONS. USE THE PRODUCT CORRECTLY AND WITH CARE FOR THE PURPOSE FOR WHICH IT IS INTENDED. FAILURE TO DO SO MAY CAUSE DAMAGE AND/OR PERSONAL INJURY AND WILL INVALIDATE THE WARRANTY. PLEASE KEEP INSTRUCTIONS SAFE FOR FUTURE USE.**

## 1. SAFETY INSTRUCTIONS

























- ✓ Before each use, check that there is no damage to the spreader and that all fixings are tight.
- ✓ Replace or repair damaged parts. *Use only recommended parts. Unauthorised parts may be dangerous and will invalidate the warranty.*
- ✓ Ensure that the operator is fully trained and competent to operate the spreader.
- ✓ Ensure that all chemical safety instructions are adhered to when handling products for use in the spreader. A full range of personal safety equipment is available from your Sealey dealer.
- ✓ Always distribute the load evenly.
- ✓ Ensure all non essential personnel keep a safe distance when the spreader is in use.
- ✓ Keep hands and feet away from moving parts.
- ✗ **DO NOT** overload the spreader - see Specification.
- ✗ **DO NOT** leave unattended, especially when loaded.
- ✗ **DO NOT** allow anybody to sit, stand, or ride on the spreader.
- ✗ **DO NOT** allow untrained personnel to use the spreader.
- ✗ **DO NOT** allow children to play in or climb onto the spreader.
- ✗ **DO NOT** use on windy days when spreading seeds or herbicides.
- ✗ **DO NOT** tow this spreader with a motorized vehicle of any sort.
- ✗ **DO NOT** use the spreader for purposes other than for which it is designed.
- ✗ **DO NOT** operate the spreader when you are tired or under the influence of alcohol, drugs or intoxicating medicines.
- ✗ When loaded, **DO NOT** operate the spreader over edges, rough surfaces etc. where the spreader is at risk of overturning.
- ☐ **WARNING!** Failure to comply with these instructions may result in damage to spreader or other property and/or personal injury.

## 2. SPECIFICATION

Model No. .... **SPB27W**  
 Capacity (Weight) ..... 27kg  
 Capacity (Volume) ..... 16ltr  
 Spread ..... 3-3.6mtr  
 Weight ..... 5.5kg  
 Dimensions (W x D x H) ..... 460 x 810 x 765mm

## 3. INTRODUCTION

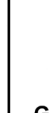
Manufactured with a strong tubular steel frame and polypropylene dispensing hopper. Fitted with nylon gear and adjustable feed system. Sprays in 360° motion to cover a large area. Suitable for a variety of horticultural agents including grit, seed, salt, fertiliser and weed killer.

Hex Bolt M6x45 4pcs  <b>1</b>	Hex Bolt M6x35 4pcs  <b>2</b>	Hex Bolt M6x30 2pcs  <b>3</b>	Hex Bolt M5x25 1pc  <b>4</b>
Carriage Bolt M6x40 2pcs  <b>5</b>	Round Head Bolt M4x20 1pc  <b>6</b>	Lock Nut M6 10pcs  <b>7</b>	Lock Nut M5 1pc  <b>8</b>
Flat Washer Ø6 2pcs  <b>9</b>	Flat Washer Ø12 2pcs  <b>10</b>	Large Flat Washer Ø6 4pcs  <b>11</b>	Split Pin 1pc  <b>12</b>
R Pin 1pc  <b>13</b>	Axle Cap 2pcs  <b>14</b>	Wing Nut M6 2pcs  <b>15</b>	
<b>16</b>  Gear Box & Axle 1pc	<b>17</b>  Hopper 1pc	<b>18</b>  Square Impeller 1pc	
<b>19</b>  Wheel Assembly Frame 2pcs	<b>20</b>  Support Leg 1pc	<b>21</b>  Handle Assembly 1pc	
<b>22</b>  Wheel 2pcs	<b>23</b>  Axle 1pc	<b>24</b>  Gauge and Lever Assembly 1pc	<b>25</b>  Connect Tube 2pcs

## 4. ASSEMBLY

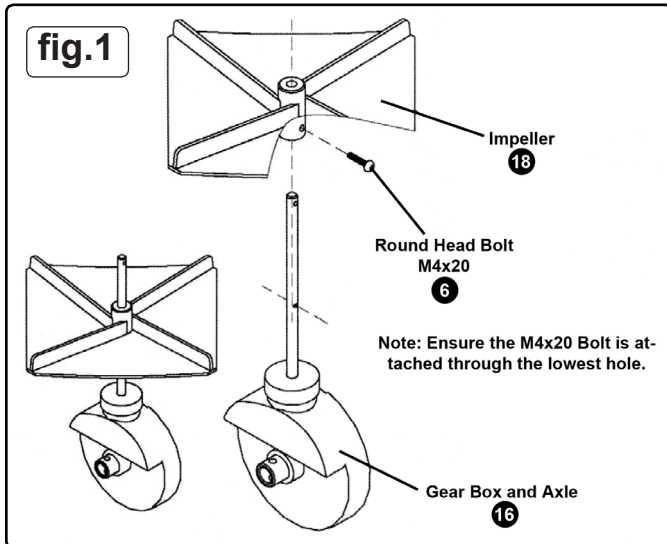

**Note!** Before assembly ensure there are no missing parts or fixtures.

4.1 Refer to fig.1.

4.1.1 Slide the Impeller (18) over the vertical axle on the gear box (16).

4.1.2 Secure the Impeller to the axle with a round head bolt M4x20 (6).

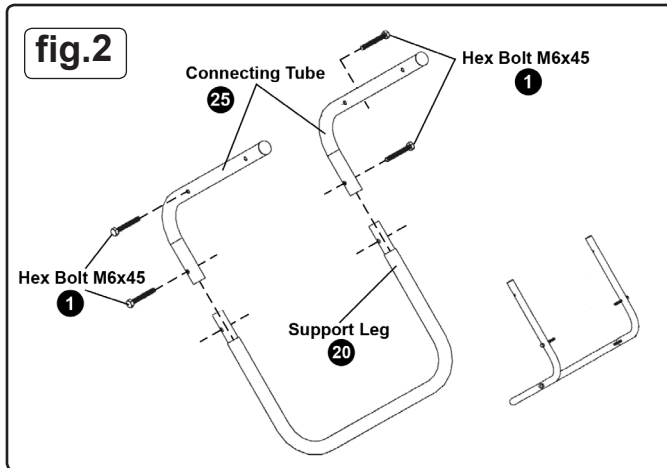

4.2 Refer to fig.2.

4.2.1 Insert the connecting tubes (25) into the support leg (20) and hold with hex bolt M6x45 (1).

4.2.2 Insert the other two hex bolts M6x45 (1) through the middle holes in the connecting tubes, ready for step 3.

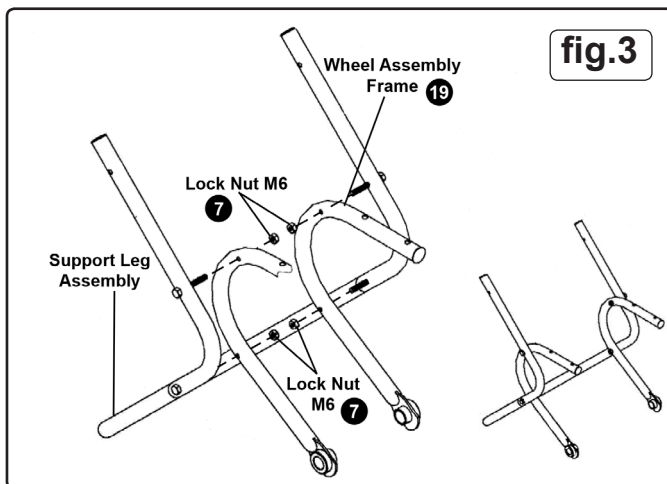

4.3 Refer to fig.3.

4.3.1 Slide the wheel assembly frame (19) over the bolts already in the support leg assembly. Secure with 4 M6 lock nuts (7).

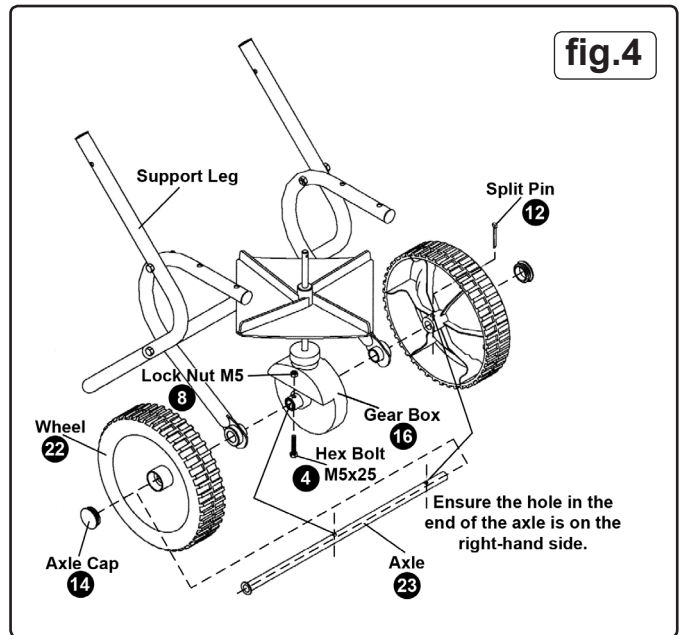

4.4 Refer to fig.4.

4.4.1 Slide the axle (23) through one wheel (22), frame and gearbox, through the other leg of the frame and then the other wheel.

4.4.2 Looking at the spreader from the front, ensure the axle (23) is inserted from the left, so that the hole in the end of the axle (23) lines up with the hole in the right hand side wheel.

4.4.3 Secure the right hand wheel (22) to the axle (23) with the split pin (12).

4.4.4 Attach the axle (23) to the gear box with the M5 hex bolt (4) and lock nut (8).

4.4.5 Insert axle caps (14) into the middle of the wheels (22).

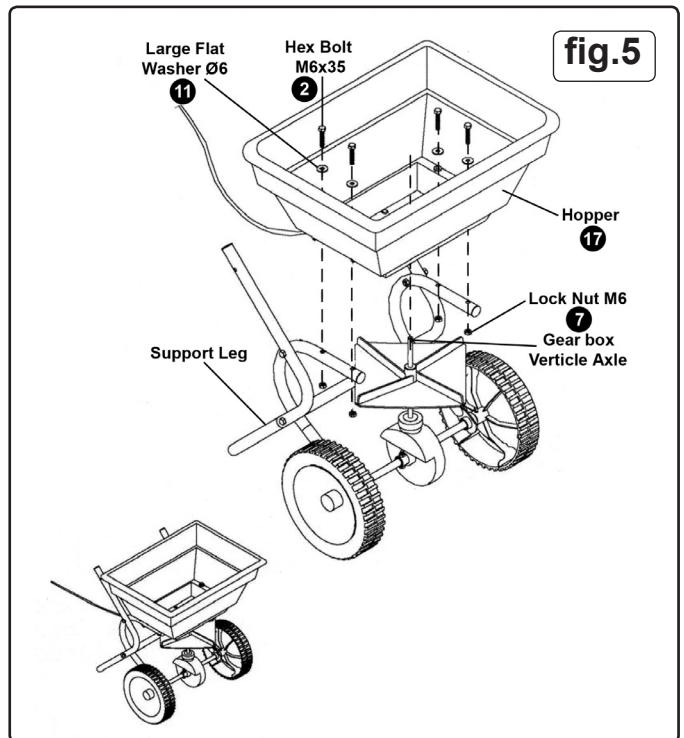

4.5 Refer to fig.5.

4.5.1 Lower the hopper (17) over the axle and onto the frame and secure with 4 hex bolts (2), large flat washers (11) and lock nuts (7).

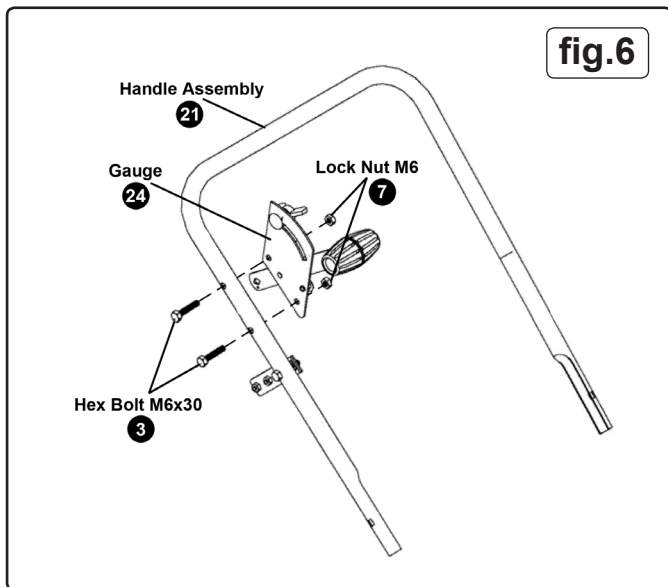

4.6 Refer to fig.6.

4.6.1 Attach the gauge and lever assembly (24) to the inside of the handle assembly (21). Secure with M6x30 hex bolts (3) and M6 lock nuts (7).

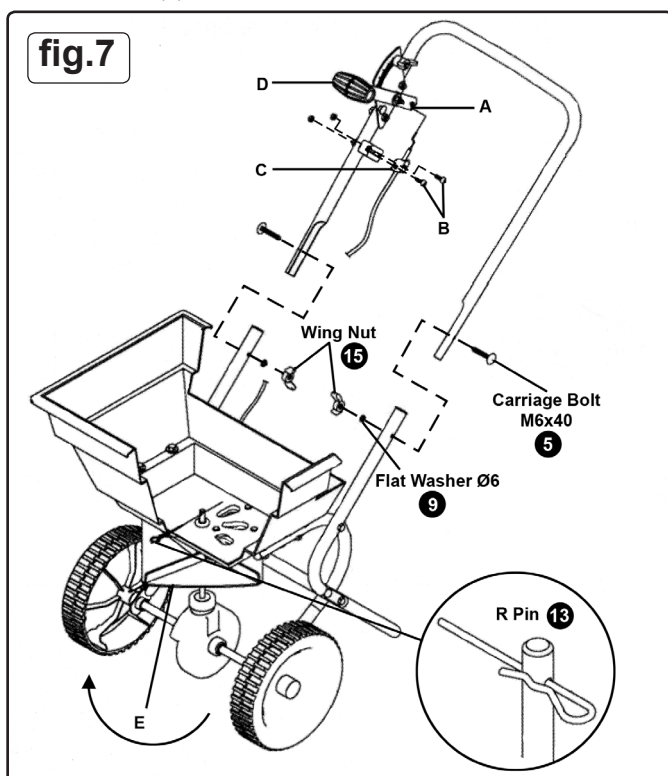

4.7 Refer to fig.7.

4.7.1 Slide the handle assembly around the support leg assembly and secure with carriage bolts (5), flat washers (9) and wing nuts (15).

4.7.2 Insert the bent end of the control clamp wire into the small hole in the lever assembly (A).

4.7.3 Remove the hex bolt from cable clamp then insert the control cable into the clamp (B,C).

4.7.4 Re-insert hex bolts to clamp control cable in place.

4.7.5 Move the lever (D) down to open the spreader slots in the bottom of the hopper. If the holes are not fully exposed, loosen the cable clamp (C) and adjust the cable.

4.7.6 Insert R-pin (13) through top of the vertical axle.

## 5. OPERATION

- 5.1 The spreader is designed to be pushed at three miles an hour, which is a brisk walking pace. Slower or faster speeds will change the spread pattern. Wet fertiliser will also change the spread pattern.
- 5.2 Use the Stop bolt on the gauge to ensure the same amount of distribution.
- 5.3 See figs.8 & 9 for suggested walking patterns depending on the level of coverage you require.
- 5.4 Always start walking prior to opening the flow control plate.
- 5.5 Every time you are ready to stop, or turn to make a new pass, close the flow control plate to stop dispensing the material and continue one more stride. This reduces waste and avoids damaging a lawn with over saturated product coverage.
- 5.6 To ensure consistent coverage, make sure each broadcast pattern slightly overlaps the previous one.
- 5.7 Make sure that any broadcast material does not come into contact with trees, shrubs and flowers that could be harmed by the material.
- 5.8 Clean the spreader thoroughly after each use paying particular attention to the shut off plate and the bottom of the hopper.

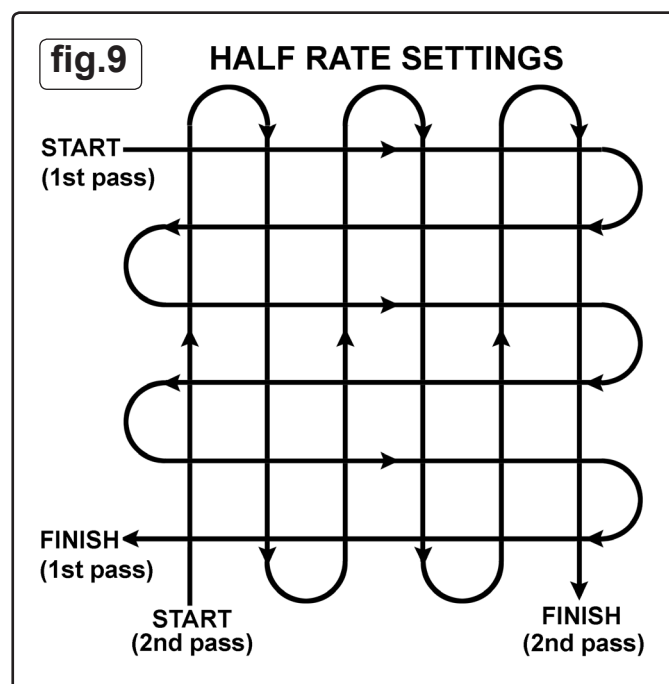
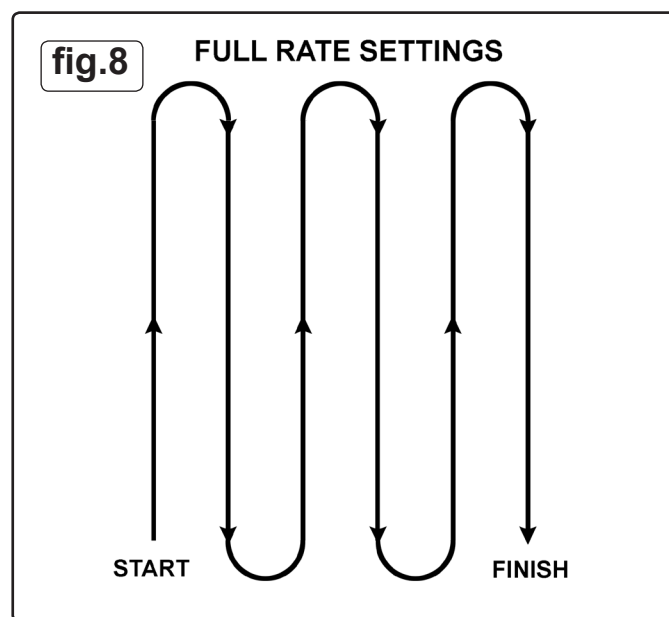

<b>(CHART 'A') SQUARE FOOT COVERAGE PER BAG (LBS/1000 SQ.FT)</b>			
<b>WEIGHT OF BAG (LBS)</b>	<b>5000 SQ.FT COVERAGE</b>	<b>10000 SQ.FT COVERAGE</b>	<b>15000 SQ.FT COVERAGE</b>
5	1.0lb	0.5lb	0.3lb
10	2.0lb	1.0lb	0.7lb
15	3.0lb	1.5lb	1.0lb
20	4.0lb	2.0lb	1.3lb
25	5.0lb	2.5lb	1.7lb
30	6.0lb	3.0lb	2.0lb
35	7.0lb	3.5lb	2.3lb
40	8.0lb	4.0lb	2.3lb
45	9.0lb	4.5lb	3.0lb
50	10.0lb	5.0lb	3.3lb
55	11.0lb	5.5lb	3.7lb

<b>(CHART 'B') SPREADER SETTINGS/SPREADER WIDTHS</b>					
<b>MATERIALS TO BE USED</b>	<b>LBS/1000 SQ.FT</b>	<b>SPREADER SETTING</b>	<b>SMALL PARTICLE SPREAD</b>	<b>MEDIUM PARTICLE SPREAD</b>	<b>LARGE PARTICLE SPREAD</b>
GRIT SEED FERTILISER WEED KILLER E.T.C.	1	5	5-6 ft	6-9 ft	9-12 ft
	2	8	5-6 ft	6-9 ft	9-12 ft
	3	10	5-6 ft	6-9 ft	9-12 ft
	4	13	5-6 ft	6-9 ft	9-12 ft
	5	15	5-6 ft	6-9 ft	9-12 ft
	6	18	5-6 ft	6-9 ft	9-12 ft
	7	20	5-6 ft	6-9 ft	9-12 ft
	8	23	5-6 ft	6-9 ft	9-12 ft
	9	25	5-6 ft	6-9 ft	9-12 ft
	10	28	5-6 ft	6-9 ft	9-12 ft
	11	30	5-6 ft	6-9 ft	9-12 ft

## 6. MAINTENANCE

### 5.9 CALCULATING THE AMOUNT OF MATERIAL NEEDED. (refer to Charts 'A' & 'B')

To calculate the amount of material needed e.g lawn fertiliser, divide the coverage stated on the packaging by the weight of the fertiliser bag. For example, a 10lb bag of fertiliser with a coverage of 10,000 sq. ft. will distribute 1lb of fertiliser every 1,000 sq.ft. at full rate or 1/2lb. of fertiliser every 1,000 sq. ft. at half rate.

5.10 For pre-calculated rates see **Chart 'A'** (Example: A 25lb bag with a 15,000 sq. ft. coverage requires 1.7lb of fertiliser per 1,000 sq.ft.

5.11 Use **Chart 'B'** to find the closest spreader setting. For example, 1.7lb per 1000 sq.ft. = spreader setting 8)

6.1 After each use clean material out of hopper.

6.1.1 Rinse/dry inside and outside of spreader after each use.

6.1.2 Before operating make sure that the tyres are inflated to the correct pressure.

6.1.3 Periodically check all fastenings are tight.

6.1.4 Annually clean and lightly lubricate parts.

6.1.5 Touch up all scratched or worn painted metal surfaces.

6.1.6 To avoid damaging the spreader never exceed the rated load capacity of 27kg.

### 6.2 STORAGE.

6.2.1 Before storing ensure that the spreader is clean and dry.

6.2.2 Store indoors or in a protected area during severe weather and in the winter months.

6.2.3 Never allow material to stay in the hopper for extended periods of time.

**NOTE:** It is our policy to continually improve products and as such we reserve the right to alter data, specifications and component parts without prior notice.

**IMPORTANT:** No liability is accepted for incorrect use of this product.

**WARRANTY:** Guarantee is 12 months from purchase date, proof of which will be required for any claim.

**INFORMATION:** For a copy of our latest catalogue and promotions call us on 01284 757525 and leave your full name and address, including postcode.

